

FEATURES:

- Wide input voltage range from +5.5V to +18V
- Nominal current measurement range : $\pm 500A$
- Peak current measurement range : $\pm 1000A$ (period : 10s)
- High accuracy for full measurement range
- Low offset current
- Wide operation temperature
- CAN2.0b compliance
- 3kV galvanic isolation
- Outline dimension: 84mm*57mm*15.5mm
- Pb-free for RoHS compliant
- IP40 compliant
- Terminal resistor

APPLICATIONS:

- EV/HEV BMS
- Battery and storage based application

GENERAL DESCRIPTION:

The shunt module is a fully integrated high precision current and temperature measurement system. The sense voltage is directly proportional to the current through the shunt. The current sensory data feedback by the CAN bus interface.

The module has measurement synchronization current channel, which uses a 16-bits ADC converter. Other features include temperature compensation, high voltage isolation, and ESD protection and low EMI performance.

The communication is based on a CAN bus 2.0b interface.

TYPICAL APPLICATION CIRCUIT & PACKAGE:

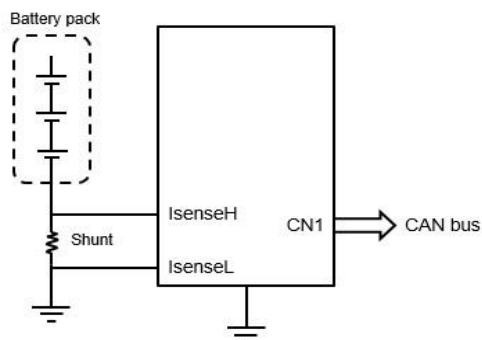

Figure 1 TYPICAL APPLICATION CIRCUIT

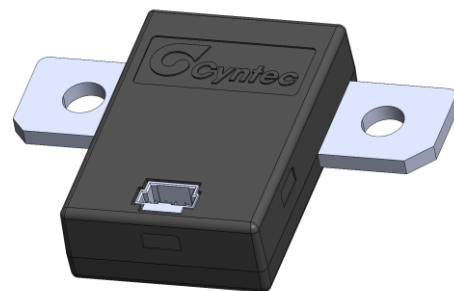

Figure 2 SHUNT MODULE

ELECTRICAL SPECIFICATIONS:

CAUTION: Do not operate at or near absolute maximum rating listed for an extended period of time. This stress may adversely impact product reliability and result in failures outside of warranty.

Symbol	Parameter	Min.	Typ.	Max.	Units
Operation condition					
V _{in}	Supply voltage	5.5	12	18	V
I _c	Current consumption		30	80	mA
T _p	Operating temperature	-40		105	°C
T _s	Ambient storage temperature	-40		125	°C
Performance data of current measurement					
I _p	Nominal measurement range	-500		500	A
ε _G	Initial accuracy(±50~±500A) ,	-0.2		0.2	% of reading
ε _L	Total accuracy(±50~±500A)	-0.5		0.5	% of reading
I _o	Error current(0~±50A)	-75 - 0.2% of reading		75 + 0.2% of reading	mA
L	Linearity	-0.01		0.01	% of Range
	Noise			40	mA(RMS)
	Resolution		19		mA
I _{OP}	Overcurrent measurement range(10s)	-1000		1000	A
	Entended load(max time) Ambient 85degree 1500A			5	S
	Entended load(max time) Ambient 85degree 2000A			4	S
	Entended load(max time) Ambient 85degree 2500A			3	S
ε _G	Accuracy overcurrent range	-1		1	% of reading
L	Linearity overcurrent range			0.1	% of Range
	Noise overcurrent range			560	mA(RMS)
	Resolution overcurrent range		150		mA
Communication					
	CAN 2.0b	250kbits/s; 500kbits/s; 1Mbits/s; terminal=120R			
	output rate	1	0.1	0.02	kHz
Connector					
	Communication header	MOLEX 560020-0420			

Other					
	Isolation voltage	3			kV _{AC}
	Creepage distance		8		mm
	Clearance distance		8		mm

QUALIFICATION:

Standard	Item	Conditions
VW80000	E-01 Long-term overvoltage	18V, Status A
VW80000	E-02 Transient overvoltage	Status A
VW80000	E-03 Transient under-voltage	Status A
VW80000	E-04 Jump start	Status A
VW80000	E-05 Load dump	Status A
VW80000	E-06 Superimposed alternating voltage	Status A
VW80000	E-07 Slow decrease and increase of the supply voltage	Operating voltage > 5V: Status A Operating voltage < =5V: Status C
VW80000	E-08 Slow decrease, abrupt increase of the supply voltage	Operating voltage > 5V: Status A Operating voltage < =5V: Status C
VW80000	E-09 Reset behavior	Status A
VW80000	E-10 Short interruptions	t1 < 100us: Status A t1 ≥ 100us: Status C
VW80000	E-11 Voltage drop	Test case 1: Test pulse "normal": Status A Test pulse "serve": Status A Test case 2: Test sequence "long": Status A Test sequence "short": Status A
VW80000	E-12 Voltage profile for on-board electrical system control	Status A
VW80000	E-13 Pin interruption	Status A
VW80000	E-14 Connector interruption	Status C
VW80000	E-15 Reverse polarity	Status C
VW80000	E-16 Ground offset	Status A
VW80000	E-17 Short circuit in signal circuit and load circuits	Status C
VW80000	E-18 Insulation resistance	Status A
VW80000	E-20 Dielectric strength	Status C

Standard	Test Name	Conditions
CISRP 25	Radiated Emissions	Class 3
CISRP 25	Conducted emissions – Voltage method	Class 3
CISRP 25	Conducted emissions – Current method	Class 3

ISO 11452-4	Bulk current injection	Status A
ISO 11452-2	Radiated Immunity	50V/m, 200~1000MHz : Status A 1000~2500MHz: Status B
ISO 7637-2	Conducted immunity, power lines only	Status A
ISO 7637-3	Conducted immunity, coupling to I/O other than power supply lines	Status A
ISO 10605	Powered-on mode ESD	Contact, $\pm 4, \pm 6, \pm 8$ KV : Status A Air, ± 15 KV : Status D
ISO 10605	Remote I/O ESD	Contact, $\pm 4, \pm 6, \pm 8$ KV : Status A
ISO 10605	Handling of devices ESD	Contact, $\pm 4, \pm 6, \pm 8$ KV: Status A Air, $\pm 6, \pm 8 \pm 15$ KV : Status A

Reliability Testing Items

Test#	Test Item	Criteria
Test 1	K-01 High-/low-temperature aging	Accuracy: $\pm 0.5\%$ ErrorCurrent: $\pm 75\text{mA} + \text{Loading}$ Linearity: $< \pm 0.05\%$ Noise: $0 \sim 0.04\text{A(RMS)}$
	K-02 Temperature step test	
	K-03 Low-temperature operation	
	K-05 Thermal shock	
	K-09 Damp heat, cyclic (with frost)	
	M-05 Mechanical shock	
	M-04 Vibration test	
	K-02 Temperature step test	
Test 2	K-01 High-/low-temperature aging	
	K-14 Damp heat, steady state Severity2	
	K-15 Condensation test with electronic assemblies	
	K-16 Thermal shock	
	High Temperature Storage	
Test 3	K-01 High-/low-temperature aging	
	K-02 Temperature step test	
	L-02 High-temperature endurance test	
	L-03 Temperature cycle endurance test	
	K-02 Temperature step test	
Test 4	Damp heat Storage	
	K-02 Temperature step test	

PIN CONFIGURATION:

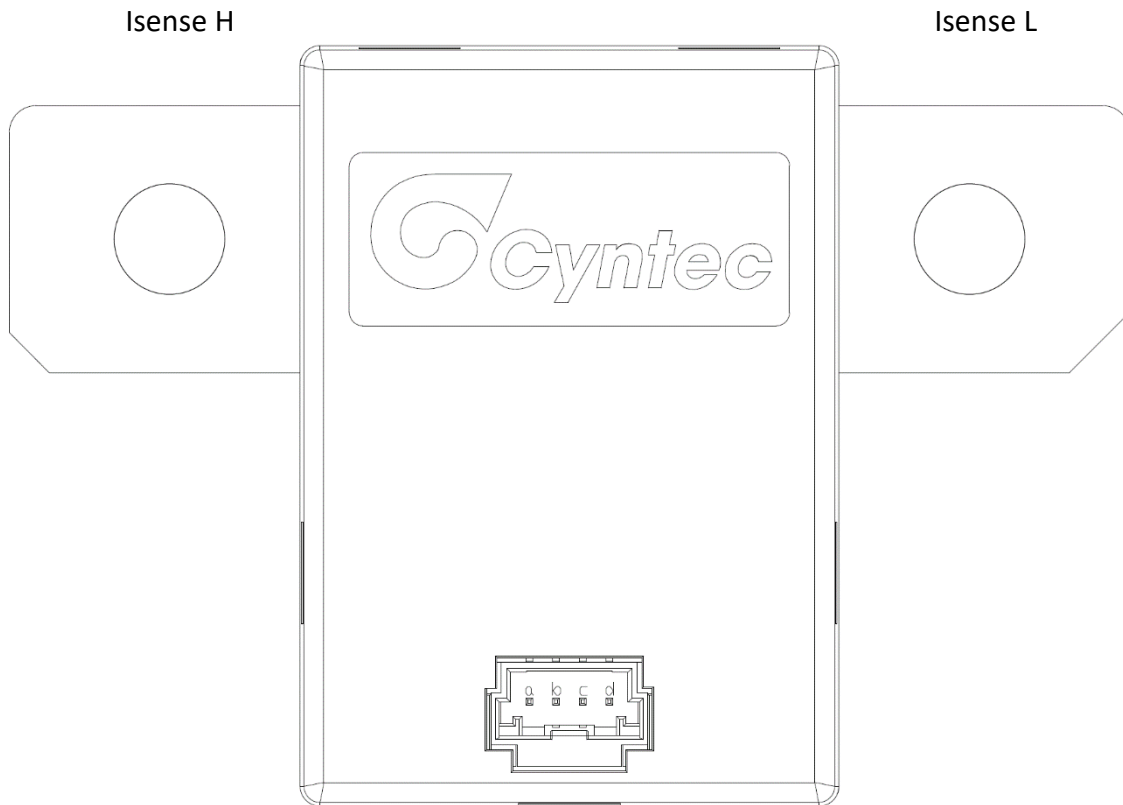

Isense H to Isense L Positive current
 Isense L to Isense H Negative current

PIN DESCRIPTION:

Connector	No. of pins	Manufacturer	Part No.	Function	Pin Definition
CN1	4	Molex	560020-0420	Power in/CAN I/O	a: Vcc input b: CAN-L c: CAN-H d: GND

*Connector Mates Part(s): 560123-0400, 505151-0401

DETAILED DESCRIPTION:

The current shunt sensor module supports three following measurement modes

Event Triggered Mode

Time Triggered Mode

Disable Mode

Event Triggered Mode

The module sends a measurement result over CAN bus when an event of software trigger command is received over CAN bus. This mode could be used for the measurement synchronization between current shunt sensor module and host. Figure 3 shows how the sensor module reacts to received trigger command. Once the trigger command is received, the module starts its current measure within 300 μ s. Note that the minimum acceptable trigger interval is 2ms.

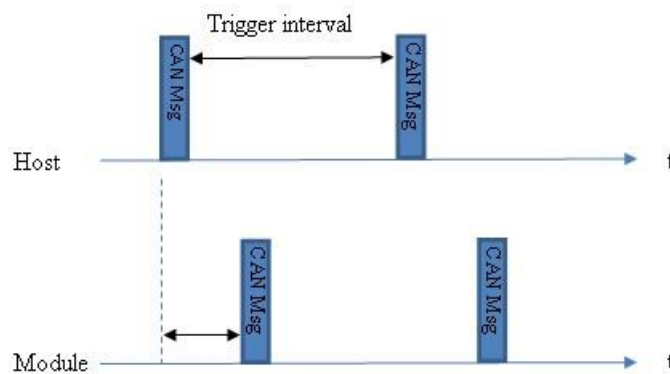

Figure 3: Illustration of Event Triggered Mode operating over CAN bus

Time Triggered Mode(Default Mode):

The module sends a measurement result over CAN bus periodically after a configured time interval is set. Figure 4 shows how Time Triggered Mode is operating, in case of time interval is configured as 10ms(Default is 10ms).

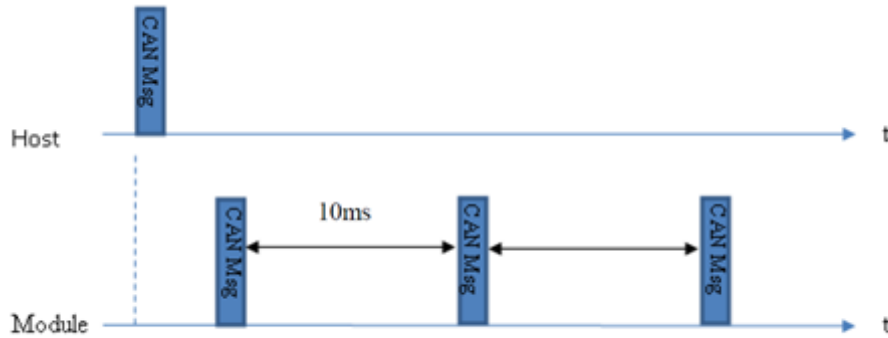

Figure 4: Illustration of Time Triggered Mode operating over CAN bus

Disable Mode:

The current measurement function is disabled and will not response to software trigger command.

Communication Interface:

The VGAS2-500TB-000 current shunt sensor module uses the standard CAN2.0 protocol. It supports bus topology as illustrated in Figure 5.

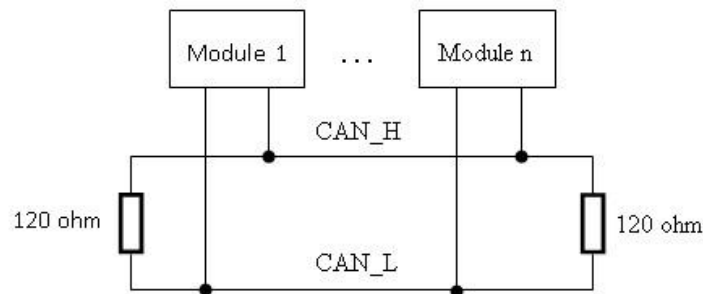
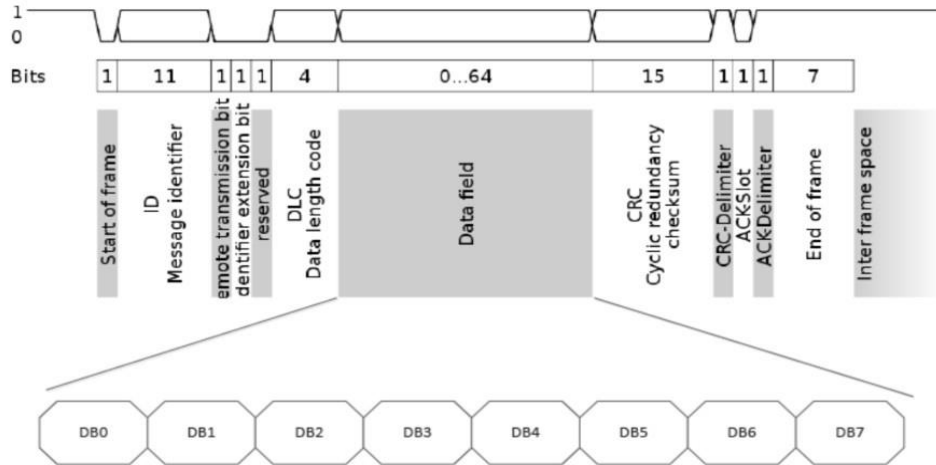

Figure 5: Bus topology

CAN Protocol:



Configurable bitrate: 500,000 bit/s

Messages Overview:

Index	Description	Default CAN-ID	Length DLC	Remark
1	Msg_Result_Current_Shunt	0x101	8	Current
2	Msg_Result_Temperature	0x525	6	Temperature
3	Msg_Command	0x411	8	Set and Get commands from Host
4	Msg_Response	0x511	8	Response of Set and Get command messages.

Msg_Result_Current_Shunt(0x101):

DB	Signal	Value	Description
0	Mux ID	0x00	Current channel
1 (Low Nibble)	Message count	0b0000 ~ 0b1111	1 byte counter, increase by 1 for every Msg_Result_Current is transmitted
1 (High Nibble)	Result state	0b0001 0b0010 0b0100 0b1000	bit 4: set if OCS is true bit 5: set if the result has reduced precision bit 6: set if the result has a measurement error bit 7: set if system error
2~5	Current result	0xnwnwnwnn	4-byte current reading (unit in mA , signed data) with temperature calibration Positive:0x00000001~0x7FFFFFFF

			Negative:0xFFFFFFFF~0x80000000
6	Reserved	0x00	
7	CRC8	0xnn	Polynomial 0x1D ($x^8 + x^4 + x^3 + x^2 + 1$) Start value and XOR value equal to 0xFF

Example for reading Current reading(Positive):

DB0	DB1	DB2	DB3	DB4	DB5	DB6	DB7
0x00	0x06	0x00	0x04	0x93	0xE0	0x00	0xCF

Decode the message:

Byte(s)	Value	Information
DB0	0x00	Current channel
DB1 low nibble	0x6	Count value is 6
DB1 high nibble	0x0	State bit = 0
DB2 – DB5	0x000493E0	Current reading is 300000mA
DB6	0x00	
DB7	0xCF	CRC8

Example for reading Current reading(Negative):

DB0	DB1	DB2	DB3	DB4	DB5	DB6	DB7
0x00	0x06	0xFF	0xFB	0x6C	0x20	0x00	0xAB

Decode the message:

Byte(s)	Value	Information
DB0	0x00	Current channel
DB1 low nibble	0x6	Count value is 6
DB1 high nibble	0x0	State bit = 0
DB2 – DB5	0xFFFFB6C20	Current reading is -300000mA
DB6	0x00	
DB7	0xAB	CRC8

Msg_Result_Temperature(0x525):

DB	Signal	Value	Description
0	Result ID	0x04	Temperature Result ID
1 (Low Nibble)	Message count	0b0000 ~ 0b1111	Cyclic counter, increase by 1 for every Msg_Result_Temperature is transmitted
1 (High Nibble)	Result state	0b0001 0b0010 0b0100 0b1000	bit 4: set if OCS is true bit 5: set if the result has reduced precision bit 6: set if the result has a measurement error bit 7: set if system error
2~5	Temperature result	0xn n n n n n n n	4-byte temperature reading (unit in 0.1°C, signed data 2's complement)

Msg_Command (0x411):

DB	Signal	Value	Description
0	Command ID	0x10	Set CAN ID of Msg_Result_Current_Shunt
1	High Byte		High Byte of new CAN ID of Msg_Result_Current_Shunt
2	Low Byte		Low Byte of new CAN ID of Msg_Result_Current_Shunt

DB	Signal	Value	Description
0	Command ID	0x14	Set CAN ID of Msg_Result_Temperature
1	High Byte		High Byte of new CAN ID of Msg_Result_Temperature
2	Low Byte		Low Byte of new CAN ID of Msg_Result_Temperature

DB	Signal	Value	Description
0	Command ID	0x50	Get CAN ID of Msg_Result_Current_Shunt

DB	Signal	Value	Description
0	Command ID	0x54	Get CAN ID of Msg_Result_Temperature

DB	Signal	Value	Description
0	Command ID	0x20	Set Module Operation Mode
1 (Low Nibble)	Operation Mode	0b0000 0b0001 0b0010	0b0000 : Disabled Mode 0b0001 : Event Triggered Mode 0b0010 : Time Trigger Mode (Default)
1 (High Nibble)	Endianness	0b0100	0b0000 : Big Endian (Motorola,Default)) 0b0100 : Little Endian (Intel)
2~3	Output Interval Time	0xnnnnnnnn	2-byte Output Interval (1ms ~ 100ms), only for Time Trigger Mode (Default:10ms)

DB	Signal	Value	Description
0	Command ID	0x60	Get Module Operation Mode

DB	Signal	Value	Description
0	Command ID	0x30	Reset Error Count
1	Error Mode	0x00 0x01	0x00 : Measurement Error 0x01 : System Error
2	Error Counter	0x00 0x01 ~ 0xFF	0x00 : Reset All Error Counters 0x01 ~ 0xFF : Reset Specified Error Counter (Reference Command ID 0x40 and 0x41)

DB	Signal	Value	Description
0	Command ID	0x31	Get Current and Temperature Result in Trigger Mode
1	Trigger Bitmap	0x01 0x04	0x01 : Current Result 0x04 : Temperature Result

DB	Signal	Value	Description
----	--------	-------	-------------

0	Command ID	0x32	Store Module Configuration (CAN ID, Baudrate, ...)
---	------------	------	--

DB	Signal	Value	Description
0	Command ID	0x34	Enable/Disable Module
1	Current Mode	0x0 0x1	0x0 : Module Disable 0x1 : Module Enable(Default)
2	Startup Mode	0x0 0x1	0x0 : Module Disable after Power Up 0x1 : Module Enable after Power Up(Default)

DB	Signal	Value	Description
0	Command ID	0x35	Set Positive Overcurrent Thresholds
1+2	Overcurrent Threshold	0~32767	Positive overcurrent threshold in 1A-steps (0 means off)
3+4	Overcurrent Clear Bit Threshold	0~32767	Positive overcurrent clear bit threshold in 1A-steps (0 means off)

DB	Signal	Value	Description
0	Command ID	0x36	Set Negative Overcurrent Thresholds
1+2	Overcurrent Threshold	0~32767	Negative Overcurrent Threshold in 1A-steps(0 means off)
3+4	Overcurrent Clear Bit Threshold	0~32767	Negative Overcurrent Clear Bit Threshold in 1A-steps(0 means off)

DB	Signal	Value	Description
0	Command ID	0x3A	Set CAN Bus Baudrate (New Baudrate will be active after Module Restart)
1	Baudrate	0x8 0x4 0x2	0x8 : 250Kbps 0x4 : 500Kbps (Default) 0x2 : 1Mbps

DB	Signal	Value	Description
0	Command ID	0x3D	Reset All Module Configuration to Default (CAN ID, Operation Mode, Baudrate, ...)

DB	Signal	Value	Description
0	Command ID	0x3F	Restart Module

DB	Signal	Value	Description
0	Command ID	0x40	Get Measurement Errors and Specified Error Count
1	Error Counter	0x00 0x01 0x02 0x03 0x04	Bitmask of Occurred Measurement Errors (error count != 0) ADC interrupt Error ADC Channel1 Overflow ADC Channel1 Underflow ADC Channel2 Overflow

		0x05	ADC Channel2 Underflow
		0x06	Reference Voltage Error of ADC
		0x07	Implausible Current Error
		0x08	NTC1 Open Circuit
		0x09	NTC2 Open Circuit
		0x0A	Calibration Data Error

DB	Signal	Value	Description
0	Command ID	0x41	Get System Errors and Specified Error Count
1	Error Counter	0x00	Bitmask of occurred system errors (error count != 0)
		0x01	Flash CRC Error
		0x02	System Clock Error
		0x03	EEPROM R/W Error
		0x04	System Init Error
		0x05	NTC Over Spec
		0x06	NTC Under Spec
		0x07	Illegal Opcode Reset
		0x08	Watchdog Reset
		0x09	EMC Reset
		0x0A	CAN RX Error
		0x0B	CAN TX Error

DB	Signal	Value	Description
0	Command ID	0x74	Get Module Status

DB	Signal	Value	Description
0	Command ID	0x75	Get Positive Overcurrent Thresholds

DB	Signal	Value	Description
0	Command ID	0x76	Get Negative Overcurrent Thresholds

Msg_Response (0x511):

DB	Signal	Value	Description
0	Response ID	0x80	Response Measurement Errors Count (Command ID : 0x40)
1	Bitmask of occurred measurement errors	0x00	
2	Occurred Measurement Error	0b00000001	0b00000001 : ADC Interrupt Error Occurred
		0b00000010	0b00000010 : ADC Channel1 Overflow Occurred
		0b00000100	0b00000100 : ADC Channel1 Underflow Occurred
		0b00001000	0b00001000 : ADC Channel2 Overflow Occurred
		0b00010000	0b00010000 : ADC Channel2 Underflow Occurred
		0b00100000	0b00100000 : Reference Voltage Error of ADC Occurred
		0b01000000	0b01000000 : Implausible Current Error Occurred

		0b10000000	0b10000000 : NTC1 Open Circuit Occurred
3	Occurred Measurement Error	0b00000001 0b00000010	0b00000001 : NTC2 Open Circuit Occurred 0b00000010 : Calibration Data Error Occurred

DB	Signal	Value	Description
0	Response ID	0x80	Response Measurement Errors Count (Command ID : 0x40)
1	Specific Counter Error	0x01 0x02 0x03 0x04 0x05 0x06 0x07 0x08 0x09 0x0A	0x01 : ADC Interrupt Error 0x02 : ADC channel1 Overflow 0x03 : ADC channel1 Underflow 0x04 : ADC channel2 Overflow 0x05 : ADC channel2 Underflow 0x06 : Reference Voltage Error of ADC 0x07 : Implausible Current Error 0x08 : NTC1 Open Circuit 0x09 : NTC2 Open Circuit 0x0A : Calibration Data Error
2	Error Count	0x00 ~ 0xFF	Number of Error Count

DB	Signal	Value	Description
0	Response ID	0x81	Response System Errors Count (Command ID : 0x41)
1	Bitmask of occurred system errors	0x00	
2	Occurred System Error	0b00000001 0b00000010 0b00000100 0b00001000 0b00010000 0b00100000 0b01000000 0b10000000	0b00000001 : Flash CRC Error Occurred 0b00000010 : System Clock Error Occurred 0b00000100 : EEPROM R/W Error Occurred 0b00001000 : System Init Error Occurred 0b00010000 : NTC Over Spec Occurred 0b00100000 : NTC Under Spec Occurred 0b01000000 : Illegal Opcode Reset Occurred 0b10000000 : Watchdog Reset Occurred
3	Occurred System Error	0b00000001 0b00000010 0b00000100	0b00000001 : EMC Reset Occurred 0b00000010 : CAN RX Error Occurred 0b00000100 : CAN TX Error Occurred

DB	Signal	Value	Description
0	Response ID	0x81	Response System Errors Count (Command ID : 0x41)
1	Specific Counter Error	0x01 0x02 0x03 0x04 0x05 0x06 0x07 0x08 0x09 0x0A 0x0A 0x0B 0x0B	0x01 : Flash CRC Error 0x02 : System Clock Error 0x03 : EEPROM R/W Error 0x04 : System Init Error 0x05 : NTC Over Spec 0x06 : NTC Under Spec 0x07 : Illegal Opcode Reset 0x08 : Watchdog Reset 0x09 : EMC Reset 0x0A : CAN RX Error 0x0B : CAN TX Error (0x01, 0x03, 0x04, 0x05, 0x06 will report via system error bit when error occur, the other errors only record)
2	Error Count	0x00 ~ 0xFF	Number of Error Count

DB	Signal	Value	Description
0	Response ID	0x90	Response for Set/Get CAN ID of Msg_Result_Current_Shunt (Command ID : 0x10 and 0x50)
1	High Byte		High Byte of CAN ID of Msg_Result_Current_Shunt
2	Low Byte		Low Byte of CAN ID of Msg_Result_Current_Shunt

DB	Signal	Value	Description
0	Response ID	0x94	Response for Set/Get CAN ID of Msg_Result_Temperature (Command ID : 0x14 and 0x54)
1	High Byte		High Byte of CAN ID of Msg_Result_Temperature
2	Low Byte		Low Byte of CAN ID of Msg_Result_Temperature

DB	Signal	Value	Description
0	Response ID	0xA0	Response for Set/Get Module Operation Mode (Command ID : 0x20 and 0x60)
1	Operation Mode	0b0000 0b0001 0b0010	0b0000 : Disabled Mode 0b0001 : Event Triggered Mode 0b0010 : Time Triggered Mode
2	Endianness	0b0100	0b0000 : Big Endian (Motorola) 0b0100 : Little Endian (Intel)
2~3	Output Interval Time	0xnnnnnnnn	2-byte Output Interval (1ms ~ 100ms), only for Time Triggered Mode

DB	Signal	Value	Description
0	Response ID	0xE2	Response for Store Module Configuration (Command ID : 0x32)

1	Status	0x0	0x0 : Store OK
---	--------	-----	----------------

DB	Signal	Value	Description
0	Command ID	0xE4	Response for Set/Get Module Status (Command ID : 0x34 and 0x74)
1	Current Mode	0x0 0x1	0x0 : Module Disable 0x1 : Module Enable
2	Startup Mode	0x0 0x1	0x0 : Module Disable after Power Up 0x1 : Module Enable after Power Up

DB	Signal	Value	Description
0	Command ID	0xE5	Response for Set/Get Positive Overcurrent Thresholds (Command ID : 0x35 and 0x75)
1+2	Overcurrent Clear Bit Threshold	0~32767	Positive overcurrent threshold in 1A-steps (0 means off,)
3+4	Overcurrent Clear Bit Threshold	0~32767	Positive overcurrent clear bit threshold in 1A-steps (0 means off)

DB	Signal	Value	Description
0	Command ID	0xE6	Response for Set/Get Negative Overcurrent Thresholds (Command ID : 0x36 and 0x76)
1+2	Overcurrent Clear Bit Threshold	0~32767	Negative Overcurrent threshold in 1A-steps (0 means off)
3+4	Overcurrent Clear Bit Threshold	0~32767	Negative Overcurrent Clear Bit Threshold in 1A-steps (0 means off)

OUTLINE DRAWING:

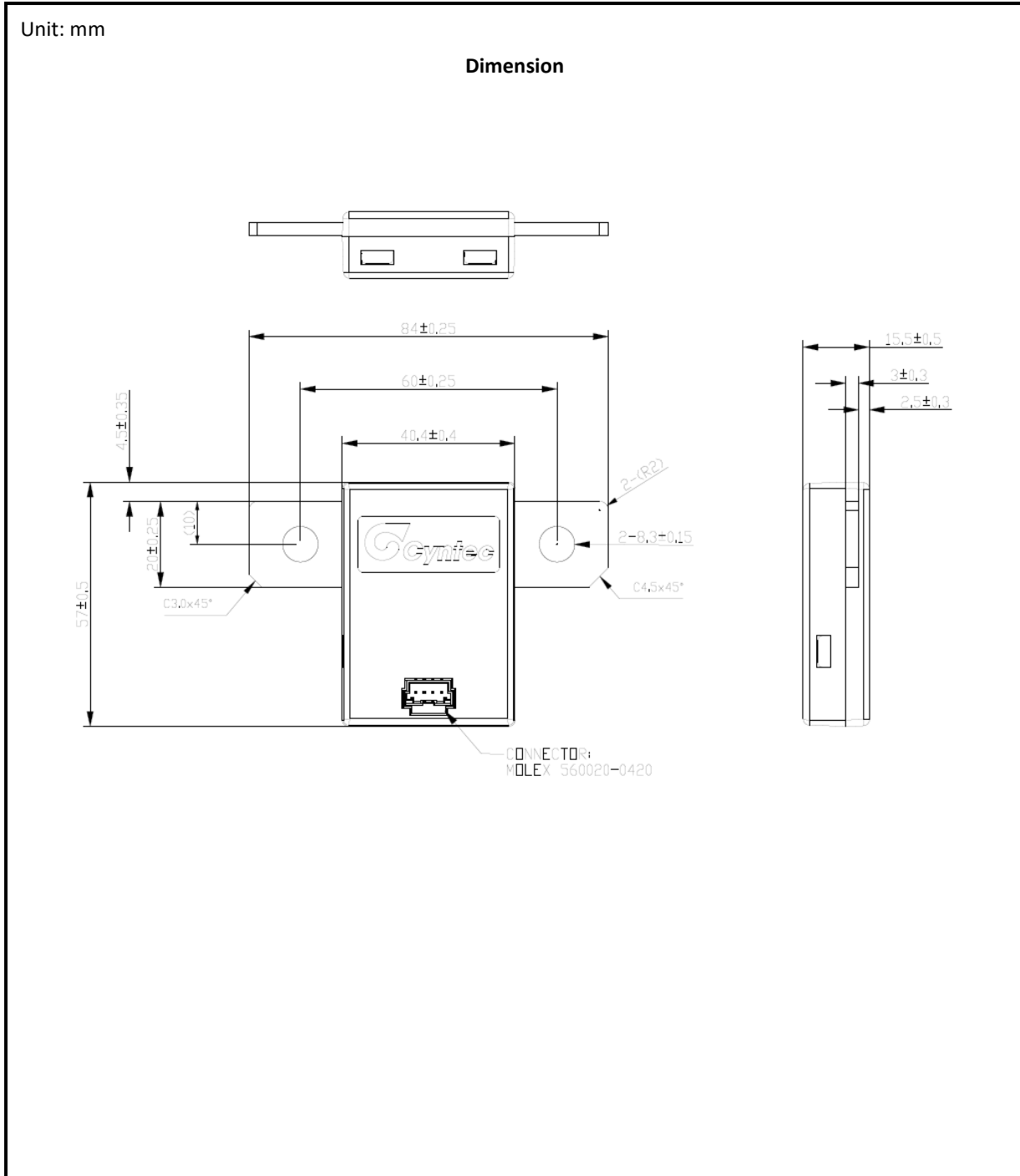

Location: Module bottom side

Size and information

Data matrix 內容:

VGAS2500TB000: YYWWXXXXXX

範例: VGAS2500TB000:2011000001

說明:

YY:年分

WW:周

XXXXXX: 000001~999999

VV: Revision:01:EVT 02:DVT 03:PVT 04:MP

文字內容:

VGAS2500TB000

YYWWXXXXXX

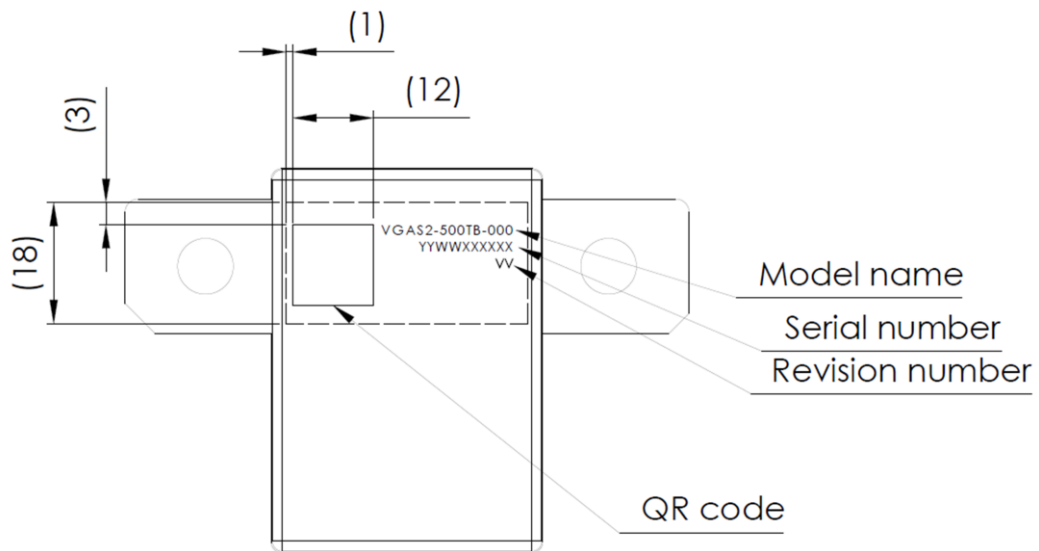

BUSBAR CONNECTION:

- Screwing the shunt module on a bus bar by using all mounting holes
- Suggestion screws: M8, the recommended torque is **10 Nm**
- Recommended overlap between the shunt and bus bar is 20mm or more
- Never use flat washers between the bus bar and the shunt
- Shunt and bus bar must be clean and free of grease

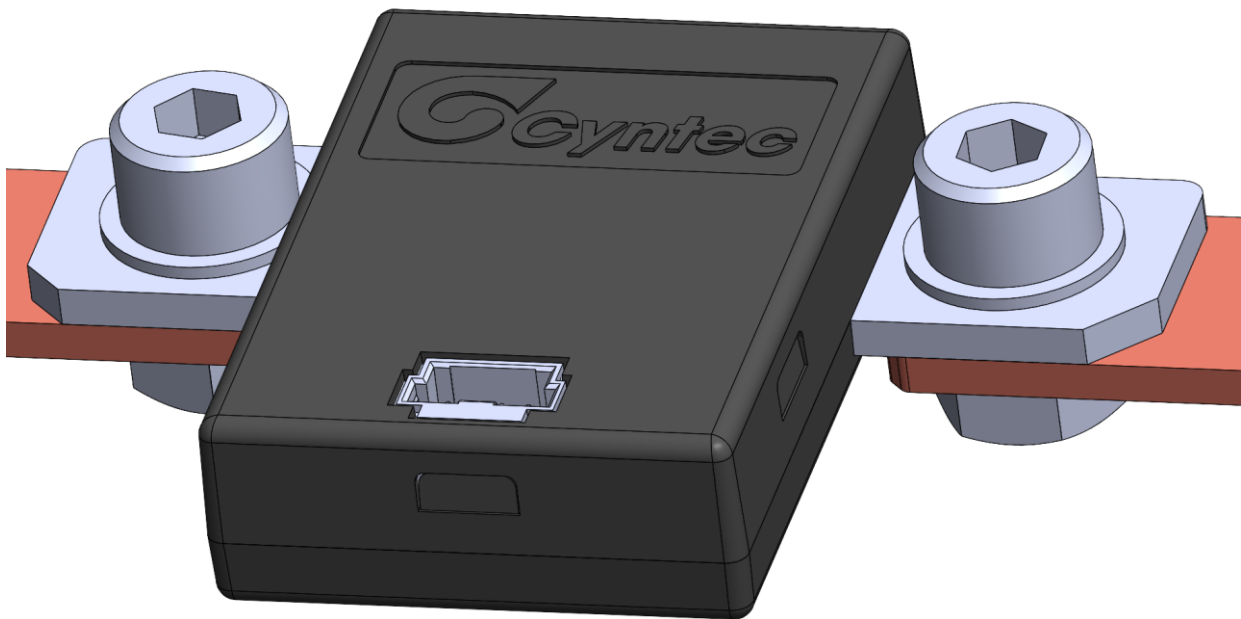

REVERSION HISTORY:

Date	Revision	Changes	
2022/4/15	A0	Release of the preliminary specification. CYNPW-221-001(A2) transfer CYNPW-224-004(A0)	JJ.FANG
2022/5/13	A1	1.add Isense H to Isense L Positive current Isense L to Isense H Negative current 2.Add feature terminal resistor	JJ.FANG
2022.11.29	A2	1.change description 0x35 0x36 0xE5 0xE6 2.change description Powered-on mode ESD 3.Handling of devices ESD 4.Update OUTLINE DRAWING	JJ.Fang
2022.12.26	A3	1.Modify Resolution overcurrent range 2.Update OUTLINE DRAWING	JJ.Fang
2023.2.24	A4	1.add CRC8	JJ.Fang
2023.3.14	A5	1.DB7 0x2D change to 0xCF	JJ.Fang
2023.4.17	A6	1.Error mode description 0x00 : Measurement Error 0x01 : System Error 2.0x20 0xA0 2-byte Output Interval (1ms ~ 100ms), only for Time Triggered Mode	JJ.Fang Neo.Chuang
2023.05.08	A7	1.Update page 1 figure 2 for shunt sensor chamfer. 2.Update page 5 PIN CONFIGURATION figure for shunt sensor chamfer. 3.Update page 21 figure for shunt sensor chamfer. 4.Add Extend load max time	JJ.Fang Neo.Chuang
Document:VPMGAS2500TB000W			
2023.05.31	A0	Initial released for preliminary datasheet 自 CYNPW-224-004(A7)轉入 1.Add 0x81 description (0x01, 0x03, 0x04, 0x05, 0x06 will report via system error bit when error occur, the other errors only record)	Mike.Hsu JJ.Fang
2023/11/24	A1	Add New function: 1. Modify CAN baud rate support 500k/bits for Bootloader Firmware upgrade through PEAKCAN	Mike Hsu/JJ.FANG
2024/01/03	A2	Add Reliability Testing table & Relative Spec	JJ.FANG